

TECHNICAL INFORMATION
AND SERVICE DATA

AWA RADIOLETTE

Models 514-M, 514-MZ

FOUR VALVE, BROADCAST, VIBRATOR
OPERATED SUPERHETERODYNES

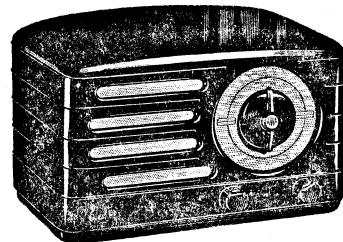

514-M and 514-MZ

AWA RADIOLA Model 718-C

FOUR VALVE, BROADCAST, BATTERY/VIBRATOR
OPERATED SUPERHETERODYNE

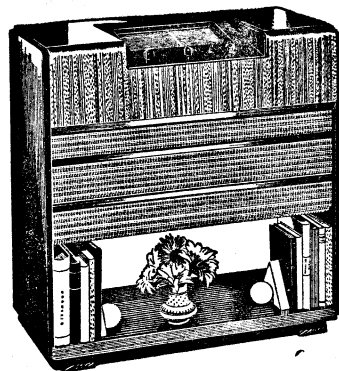

718-C

ISSUED BY
AMALGAMATED WIRELESS (A/SIA.) LTD.

ELECTRICAL SPECIFICATIONS.

FREQUENCY RANGE.....540-1600 Kc/s (555-187.5 M)

INTERMEDIATE FREQUENCY 455 Kc/s

BATTERY COMPLEMENT:

Model 514-M, 514-MZ—1—4 volt accumulator

Model 718-C—Battery operation

	Cable with tips	Cable with plugs
(1) 1—4 volt accumulator } 2—45 volt "B" batteries }	19183	19803
(2) 1—1.5 volt dry cell "A" battery } 2—45 volt "B" batteries }	19182	19801

NOTE: If a 1.5 volt dry cell "A" battery is used, it is necessary, if dial illumination is required, to remove the dial lamp cables from the terminals on top of the chassis and to connect the cable to the outer terminals of a 4.5 volt battery—see diagram "Battery Connections."

Vibrator Power Unit Operation: 1 4 volt accumulator.

Vibrator Power Unit:

Models 514-M, 514-MZ 20420

Model 718-C 19190

Battery Consumption.

Models 514-M, 514-MZ. 4 volt accumulator 0.8 amp.

Model 718-C 4 volt "A" battery 0.15 amp.
1.5 volt "A" battery 0.25 amp.
"B" battery 14 mA
Vibrator operation 0.9 amp.

Dial Lamps.

Models 514-M, 514-MZ 6.0 volt, 0.15 amp. M.E.S.

Model 718-C 6.3 volt, 0.25 amp. M.E.S.

Fuse.

Battery operation (718-C only) $\frac{1}{4}$ amp.

Vibrator operation 3 amp.

Valve Complement.

- (1) 1R5 Converter
- (2) 1T4 I.F. Amplifier
- (3) 1S5 Detector, A.F. Amplifier, A.V.C.
- (4) 3V4 Output

Vibrator Cartridge.

Models 514-M, 514-MZ: A.W.A. Oak type V 5278

Model 718-C: A.W.A. Oak type V 6804

Loudspeaker (Permanent Magnet).

Model 514-M

5 inch—code number AC32
Transformer—XA8
V.C. Impedance—3 ohms at 400 C.P.S.

Model 514-MZ

5 inch—code number AC39
Transformer—XA8
V.C. Impedance—3 ohms at 400 C.P.S.

Model 718-C

7 inch—code number AY40
Transformer—XA8
V.C. Impedance—3 ohms at 400 C.P.S.

Undistorted Power Output, 200 milliwatts.

Controls.

Models 514-M, 514-MZ—Combined On/Off switch and Volume—Left hand control. Tuning—Right-hand control.

Model 718-C. Combined On/Off switch and Tone—Left-hand control.

Volume—Centre control.
Tuning—Right-hand control.

MODEL 514-MZ — CIRCUIT CODE.

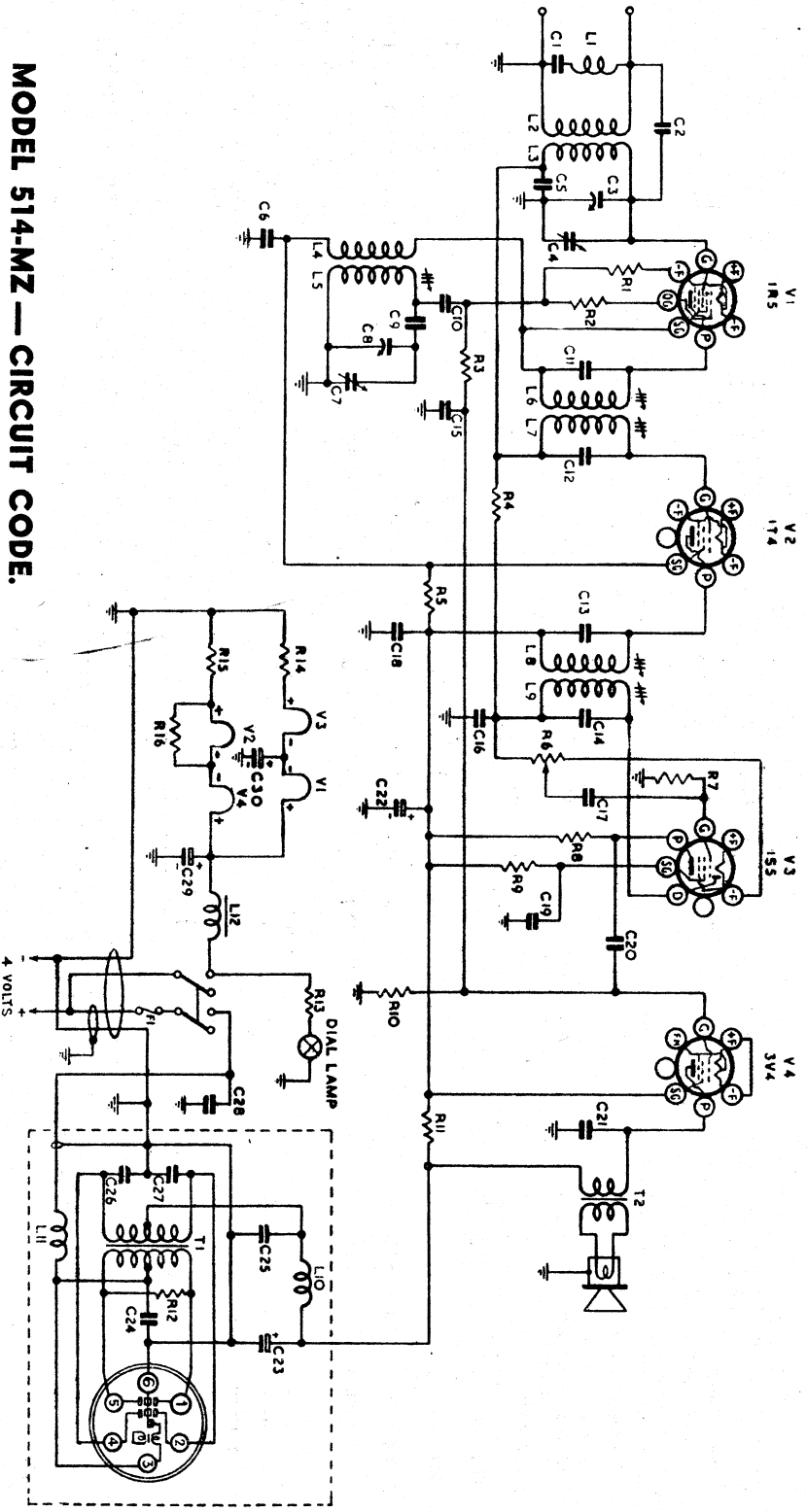

Code No.	Description	Part No.	Code No.	Description	Part No.	Code No.	Description	Part No.	Code No.	Description	Part No.
INDUCTORS											
L1	Filter Unit	9382	R8	1 megohm $\frac{1}{2}$ watt	C8	12-430 uuf tuning	C24	0.4 uF paper 200 V			
L2, L3	Aerial Coil	7647A	R9	3.2 megohms 1 watt	C9	470-uuf $\pm 2\frac{1}{2}\%$ podder	C25	0.1 uF paper 200 V			
L4, L5	Oscillator Coil	7647A	R10	1.0 megohms $\frac{1}{2}$ watt	C10	70 uuf mica	C26	0.02 uF paper 600 V			
L6, L7	1600-540 Kc/s	7638	R11	1000 ohms $\frac{1}{2}$ watt	C11	70 uuf mica	C27	0.02 uF paper 600 V			
L8, L9	1st I.F. Transformer	22700	R12	500 ohms $\frac{1}{2}$ watt	C12	70 uuf mica	C28	0.4 uF paper 200 V			
L10	2nd I.F. Transformer	22703	R13	Not used	C13	70 uuf mica	C29	400 uF 12 P.V. Electrolytic			
L11	R.F. Choke	13803	R14	25 ohms 1 watt	C14	70 uuf mica	C30	400 uF 12 P.V. Electrolytic			
L12	R.F. Choke	3149	R15	12 ohms 1 watt	C15	50 uuf mica					
	Low Tension Filter Choke	19155	R16	22 ohms $\frac{1}{2}$ watt	C16	200 uuf mica					
RESISTORS.											
R1	0.1 megohm $\frac{1}{2}$ watt		C1	50 uuf mica	C17	0.025 uF paper 400 V					
R2	2000 ohms $\frac{1}{2}$ watt		C2	4 uuf mica	C18	0.1 uF paper 200 V					
R3	32 megohms $\frac{1}{2}$ watt		C3	12-430 uuf tuning	C19	0.05 uF paper 200 V					
R4	1.6 megohms $\frac{1}{2}$ watt		C4	3-25 uuf trimmer (on gang)	C20	0.025 uF paper 400 V					
*R5	10,000 ohms $\frac{1}{2}$ watt		C5	0.05 uF paper 200 V	C21	0.0025 uF paper 600 V					
R6	0.5 megohm Volume Control (with switch)		C6	0.05 uF paper 200 V	C22	20 uF 200 P.V. Electrolytic					
R7	10 megohms 1 watt		C7	3-25 uuf trimmer (on gang)	C23	20 uF 200 P.V. Electrolytic					
CAPACITORS.											
TRANSFORMERS.											
LOUDSPEAKER.											
FUSES.											

*In some receivers R5 may be 15,000 ohms $\frac{1}{2}$ watt

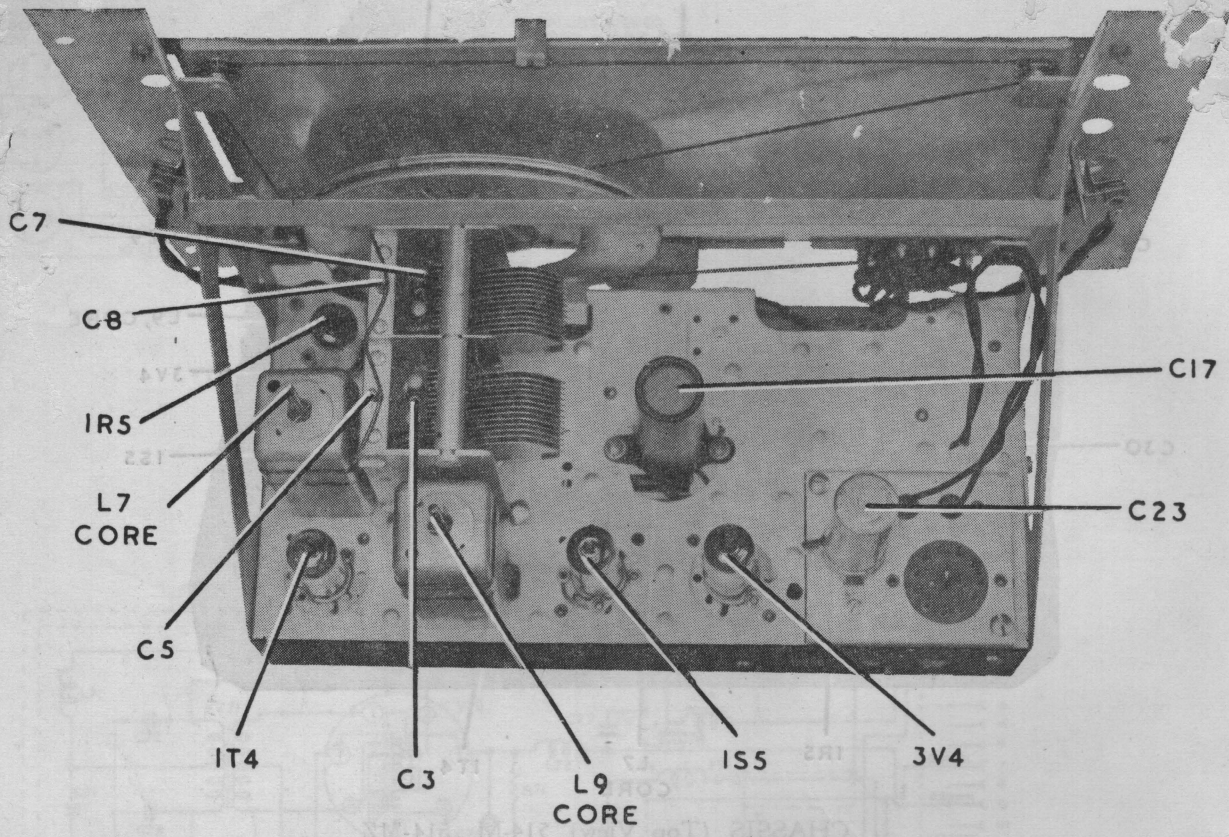

CHASSIS (Top View) 718-C

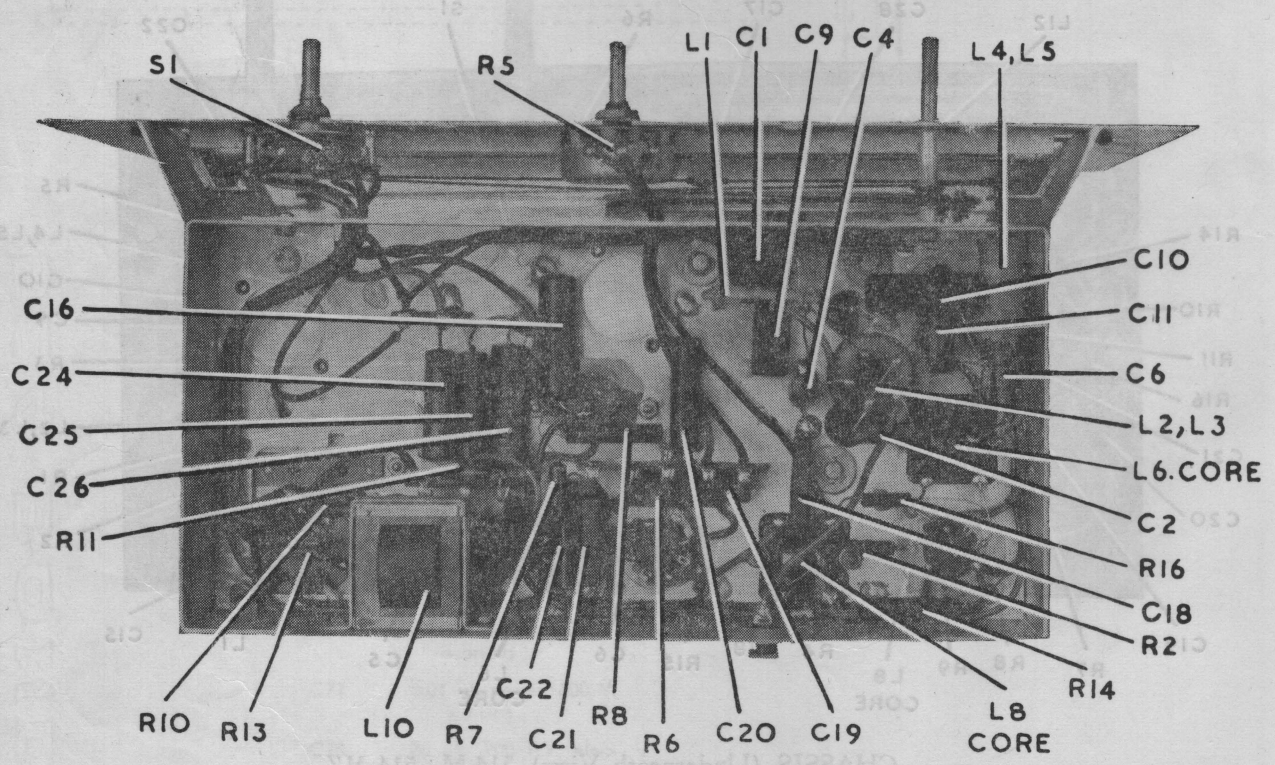

CHASSIS (Underneath View) 718-C

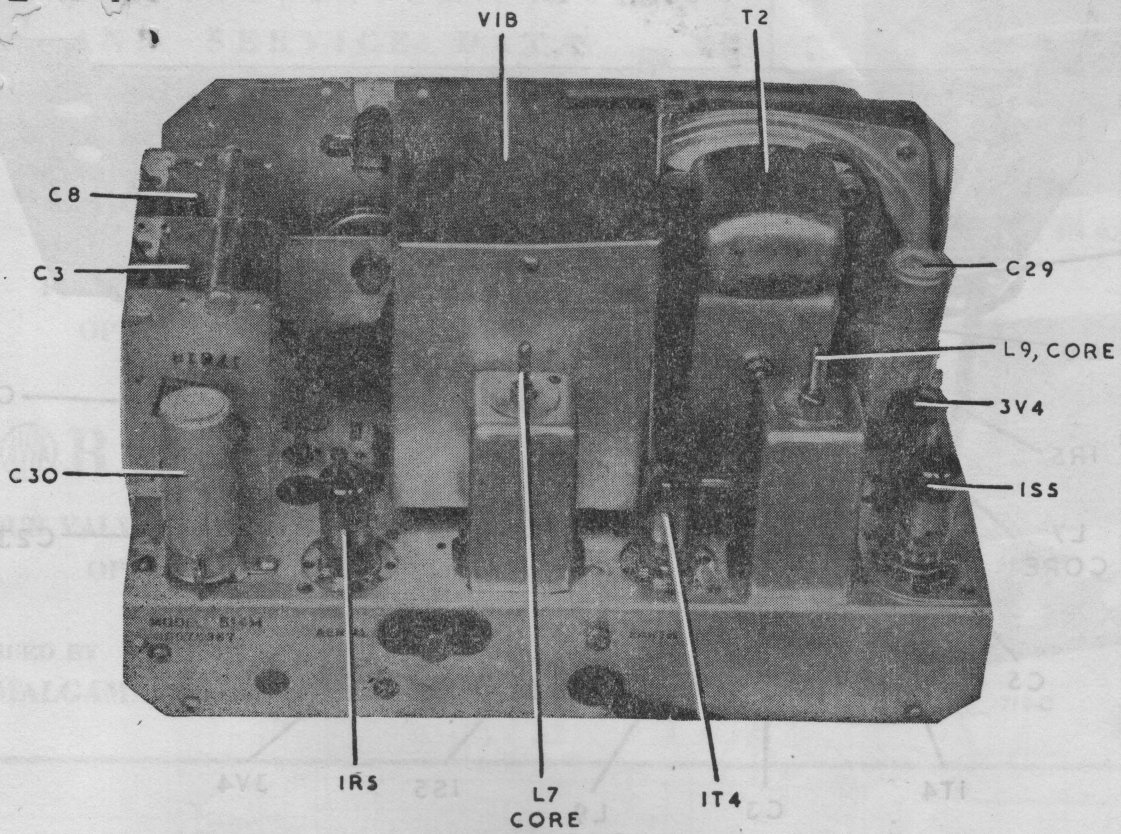

CHASSIS (Top View) 514-M, 514-MZ

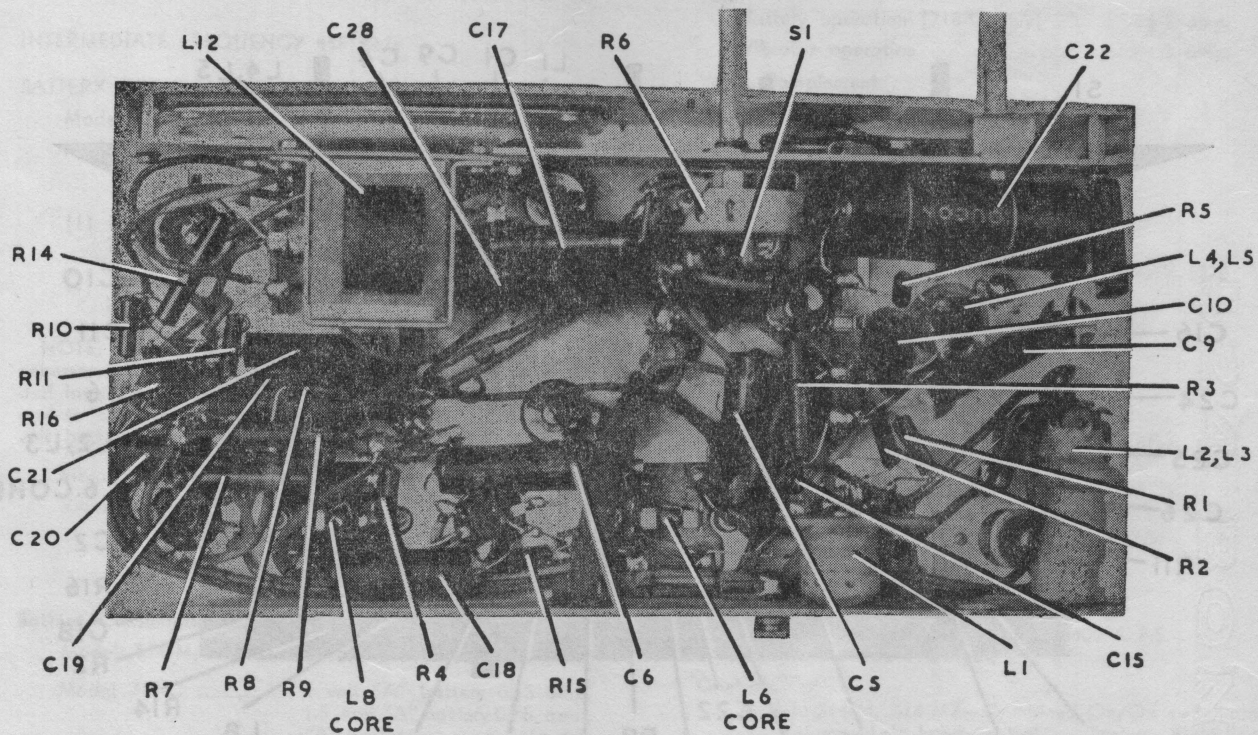

CHASSIS (Underneath View) 514-M, 514-MZ

MECHANICAL SPECIFICATIONS.

Cabinet Dimensions (inches)	Height	Width	Depth	Weight (nett lbs.)	
514-M, 514-MZ	7 $\frac{3}{8}$	11 $\frac{1}{4}$	5 $\frac{3}{4}$	514-M, 514-MZ	13 lbs.
718-C				718-C	48 lbs.
Chassis Base Dimensions (ins.)	2	10 $\frac{1}{2}$	5 $\frac{1}{2}$	Cabinet Finish	
Overall Chassis Height (ins.)	6 $\frac{1}{4}$			514-M, 514-MZ	Moulded Ivory, Jade, Walnut
				718-C	Walnut veneer

ALIGNMENT PROCEDURE.

Manufacturer's Setting of Adjustments.

The receiver is tested by the manufacturer and all adjusting screws are sealed. Re-alignment should be necessary only when components in tuned circuits are repaired or replaced, or when it is found that the seals over the adjusting screws have been broken.

It is especially important that the adjustments should not be altered unless in association with the correct testing instruments listed below.

Under no circumstances should the plates of the ganged tuning capacitor be bent, as the unit is accurately aligned during manufacture and cannot be re-adjusted unless by skilled operators using specialised equipment.

For all alignment operations connect the "low" side of the signal generator to the receiver chassis, and keep the generator output as low as possible to avoid A.V.C. action. Also, keep the volume control in the maximum clockwise position.

Testing Instruments.

- (1) A.W.A. Junior Signal Generator, type 2R3911.
- (2) A.W.A. Modulated Oscillator, type J6726.
If the modulated oscillator is used, connect an 0.25 megohm non-inductive resistor across the output terminals.
- (3) A.W.A. Output Meter, type 2M8832.

ALIGNMENT TABLE.

Order	Connect "high" side of generator to:	Tune Generator to:	Set Receiver Dial to:	Adjust for maximum peak output
1	Aerial Section of Gang. (Rear portion.)	455 Kc/s	540 Kc/s	L9 Core
2	Aerial Section of Gang. (Rear portion.)	455 Kc/s	540 Kc/s	L8 Core
3	Aerial Section of Gang. (Rear portion.)	455 Kc/s	540 Kc/s	L7 Core
4	Aerial Section of Gang. (Rear portion.)	455 Kc/s	540 Kc/s	L6 Core
Repeat the above adjustments until the maximum output is obtained.				
5	Aerial Terminal	600 Kc/s	600 Kc/s	L.F. Osc. Core Adj. (L5)*
6	Aerial Terminal	1500 Kc/s	1500 Kc/s	H.F. Osc. Adj.†
7	Aerial Terminal	1500 Kc/s	1500 Kc/s	H.F. Aer. Adj.‡

*Rock the tuning control back and forth through the signal.

†C7 in models 514-M, 514-MZ; C8 in model 718-C.

‡C4 in models 514-M, 514-MZ; C5 in model 718-C.

Loudspeaker Service.

It is inadvisable to attempt loudspeaker repairs other than replacement of the transformer. The fitting of a new cone should be done only by Service Departments suitably equipped to do the work.

Chassis Removal.

Models 514-M, 514-MZ. First remove the control knobs and felt washers—each knob is held by a set screw. Then remove two screws from underneath the cabinet and withdraw the chassis.

Model 718-C. (1) Remove the knobs and felt washers. The knobs are each held by a set screw.

(2) Disconnect the loudspeaker and vibrator cables.

(3) The chassis is held in the cabinet by four winged nuts, two at each end of the dial frame assembly. Removal of these enables the chassis to be withdrawn from the cabinet.

Dial Pointer Adjustment.

Models 514-M, 514-MZ. Should the pointer become displaced it can be reset as follows:—

Tune a known station by ear and note any inaccuracy of the pointer. If it is necessary to turn the pointer slightly clockwise, turn the tuning control fully clockwise and then turn the pointer sufficiently to correct the error.

If it is necessary to turn the pointer slightly anti-clockwise, turn the tuning control fully anti-clockwise and then turn the pointer to correct the error.

Model 718-C. The dial pointer is held in position on the drive cord by two rubber-lined clips. To alter the position of the pointer, loosen the holding clips slightly and move the pointer in the required direction. It is important to re-clip the clips after any adjustment of the pointer.

Tuning Drive Cord Replacement.

Models 514-M, 514-MZ. Disconnect the spring from the loading pulley. The accompanying diagram shows the route of the cord and the method of attachment. The cord is made from a 27½ inch cut length, which allows for the knot at each end. When fitting, apply tension to the cord during the operation and use a pair of round-nose pliers to bend the hook round the anchor plate to take up any slack. Place the loading pulley on the drive cord and replace the spring.

Model 718-C. Follow the diagram which is affixed to the back of the dial frame assembly. This shows the route of the cord and the method of attachment.

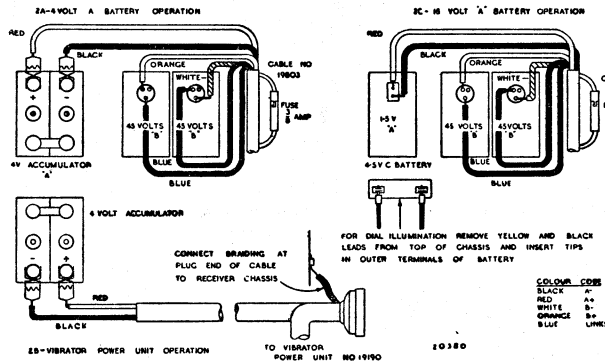
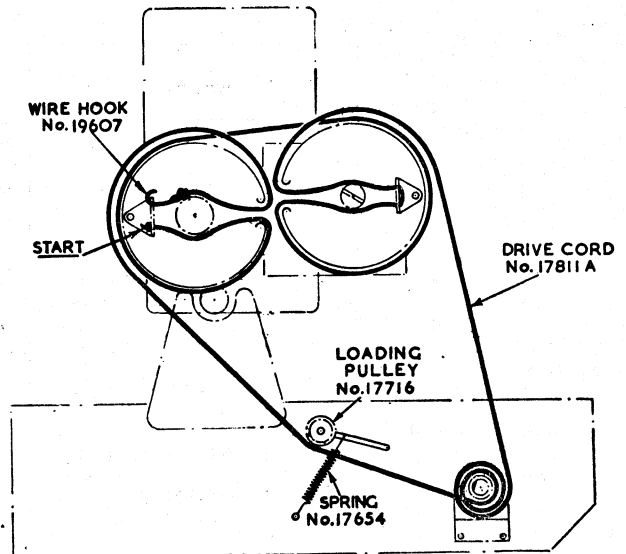

Battery Connections. Model 718-C

SOCKET VOLTAGES. MODELS 514-M, 514-MZ.

Valve	Bias Volts	Screen Grid to Chassis Volts	Anode to Chassis Volts	Anode Current mA	Filament Volts
1R5 Converter	0	45*	45*	0.5	1.3-1.4
1T4 I.F. Amplifier	0	45*	85	2.7	1.3-1.4
1S5 Det., A.V.C., A.F. Amp.	0	25†	20†	0.07	1.3-1.4
3V4 Output	-6.5‡	85	90	8.5	1.3-1.4

Total Battery Current—0.8 amp.

Measured with no signal input. Volume Control maximum clockwise.

*These readings may vary depending on the resistance of the voltmeter used.

‡Cannot be measured with an ordinary voltmeter.

SOCKET VOLTAGES. MODEL 718-C.

Valve	Bias Volts		Screen Grid to Chassis Volts		Anode to Chassis Volts		Anode Current mA		Filament Volts
	B	V	B	V	B	V	B	V	
1R5 Converter	0	0	45*	45*	45*	45*	0.75	0.75	1.3-1.4
1T4 I.F. Amp.	0	0	45*	45*	84	85	2.5	2.7	1.3-1.4
1S5 Det., A.V.C., A.F. Amp.	0	0	25+	25+	20+	20+	0.07	0.07	1.3-1.4
3V4 Output	-5.5	-5	84	85	80	80	8.5	9.5	1.3-1.4

Measured with no signal input. Volume Control maximum clockwise.

*These readings may vary, depending on the resistance of the voltmeter used.

+Cannot be measured with an ordinary voltmeter.

PLUGS VIEWED FROM WIRING SIDE.

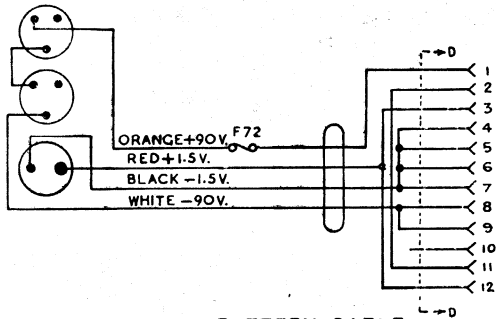

BATTERY CABLE
No. 19801

PLUGS VIEWED FROM WIRING SIDE.

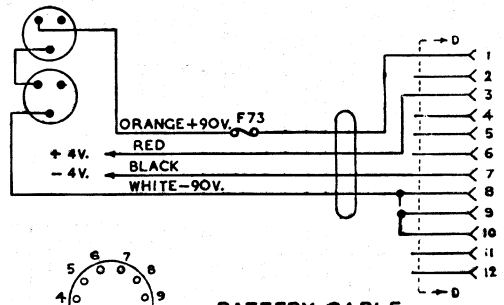

BATTERY CABLE
No. 19803

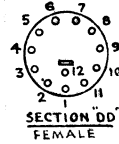

VIBRATOR POWER UNIT No. 19190

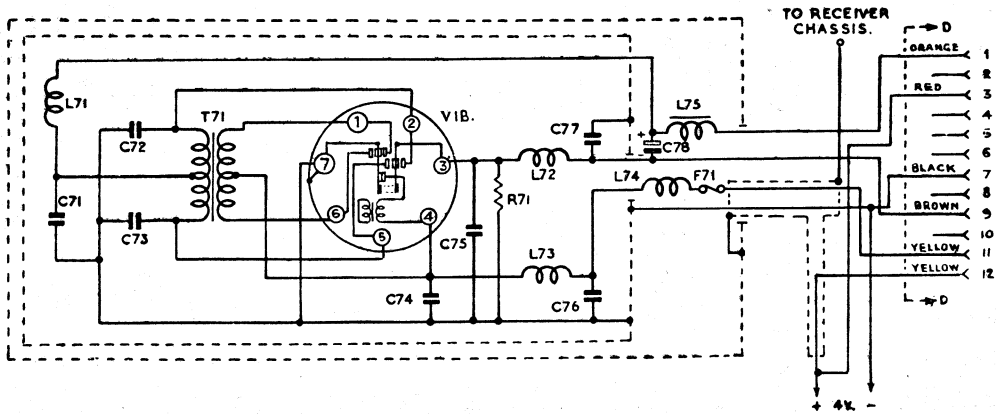

L71	R.F. choke	13809
L72	R.F. choke	13809
L73	R.F. choke	3149
L74	R.F. choke	3149
L75	R.F. choke	8321
R71	150 ohms, 1 watt, W.W.	
C71	0.01 uF paper, 600 V. working	
C72	0.02 uF paper, 600 V. working	
C73	0.02 uF paper, 600 V. working	
C74	0.1 uF paper, 400 V. working	
C75	0.01 uF paper, 600 V. working	
C76	0.1 uF paper, 400 V. working	
C77	0.01 uF paper, 600 V. working	
C78	20 uF, 200 P.V. electrolytic	
T71	Vibrator transformer	17568

D.C. RESISTANCE OF WINDINGS.

Winding	D.C. Resistance in Ohms
Aerial Coil	
Primary (L2)	9.5
Secondary (L3)	3.5
Oscillator Coil	
Primary (L4)	2
Secondary (L5)	6.5
I.F. Transformer Windings	8
I.F. Filter (L1)	17+
LT Choke	
514-M, 514-MZ (L12)	*
718-C (L10)	*
Smoothing Choke	
718-C only (L75)	200
R.F. Filter Choke	
514-M, 514-MZ (L10)	9
(L11)	*
718-C (L71, L72)	9
(L73, L74)	*
Loudspeaker Input Transformer.	
XA8 Primary	425 or 510
Secondary	*
Vibrator Transformer	
514-M, 514-MZ Primary	*
Secondary	500
718-C Primary	*
Secondary	300

The above readings were taken on a standard chassis, but substitution of materials during manufacture may cause variations, and it should not be assumed that a component is faulty if a slightly different reading is obtained.

*Less than 1 ohm.

+In some receivers this reading may be as high as 60 ohms.

MECHANICAL REPLACEMENT PARTS.

Item	Part No.	Item	Part No.
Cabinet 514-M, 514-MZ	19680	Drive Drum Assembly (718-C only)	22542
718-C	D4	Dial Pointer (514-M, 514-MZ only)	19514
Cable, Battery 514-M, 514-MZ	17644	Knob 514-M, 514-MZ	17603
With Tips	19803	718-C	4589
718-C 4 volt	19183	Socket Valve	19965
1.5 volt	19182	Spindle, tuning drive assembly	
Cable, Loudspeaker (718-C only)	22897	514-M, 514-MZ	17647
Cable, volume control		718-C	22388
(514-M, 514-MZ only)	15932	Strip tag	
Chassis end		514-M, 514-MZ	
514-M, 514-MZ (Strap)	17634	1 way	7628
718-C Left Hand	22648	4 way	8022
Right Hand	22647	5 way	15926
Dial Scale		718-C	
514-M	20288	2 way	8863
514-MZ	22518 or 23305	3 way	8821
718-C	22629 or 23316	5 way	15926
Dial Frame Assembly		Vibrator Power Unit	
514-MZ	22669	514-M, 514-MZ	20420
718-C	20343C	718-C	19190
		Terminal Aerial	17717

MODEL 514-M — CIRCUIT CODE.

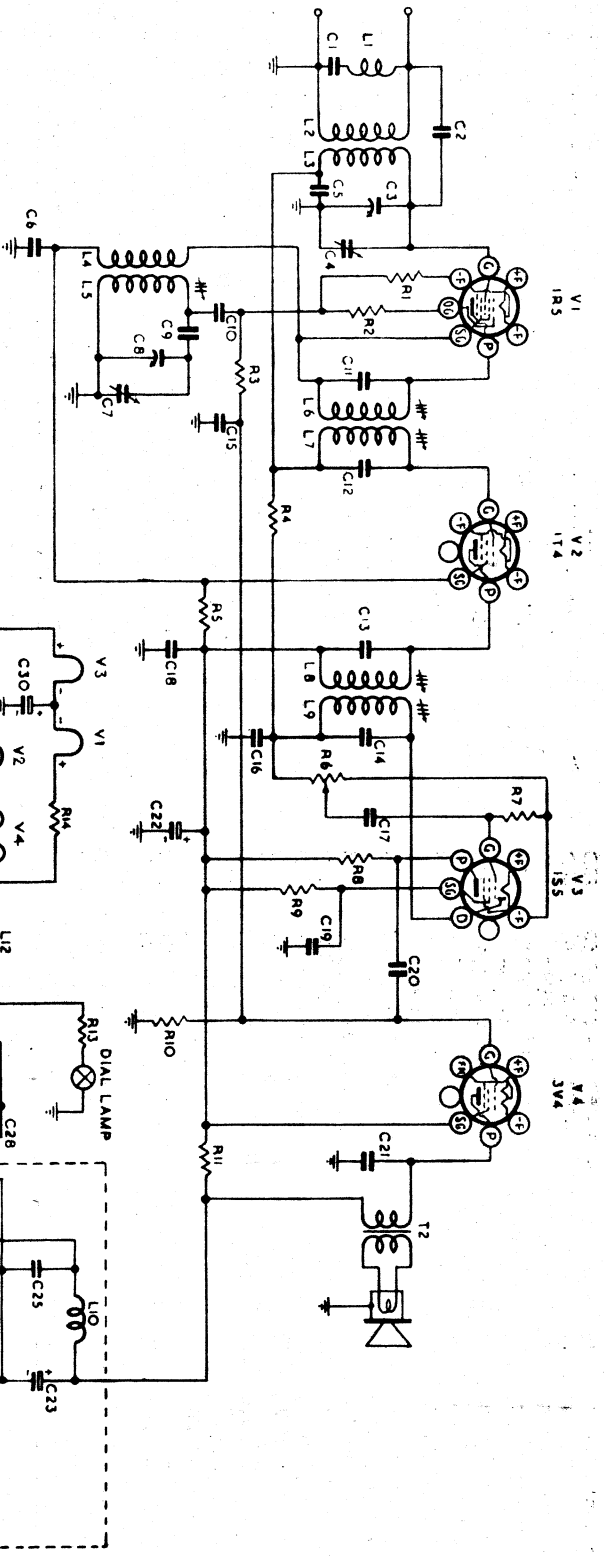

Code No.	Description	Part No.
----------	-------------	----------

Code No.	Description	Part No.
----------	-------------	----------

Code No.	Description	Part No.
----------	-------------	----------

Code No.	Description	Part No.
----------	-------------	----------

Code No.	Description	Part No.
----------	-------------	----------

Code No.	Description	Part No.
----------	-------------	----------

Code No.	Description	Part No.
----------	-------------	----------

Code No.	Description	Part No.
----------	-------------	----------

Code No.	Description	Part No.
----------	-------------	----------

Code No.	Description	Part No.
----------	-------------	----------

Code No.	Description	Part No.
----------	-------------	----------

Code No.	Description	Part No.
----------	-------------	----------

Code No.	Description	Part No.
----------	-------------	----------

Code No.	Description	Part No.
----------	-------------	----------

Code No.	Description	Part No.
----------	-------------	----------

Code No.	Description	Part No.
----------	-------------	----------

Code No.	Description	Part No.
----------	-------------	----------

Code No.	Description	Part No.
----------	-------------	----------

Code No.	Description	Part No.
----------	-------------	----------

Code No.	Description	Part No.
----------	-------------	----------

Code No.	Description	Part No.
----------	-------------	----------

Code No.	Description	Part No.
----------	-------------	----------

Code No.	Description	Part No.
----------	-------------	----------

Code No.	Description	Part No.
----------	-------------	----------

Code No.	Description	Part No.
----------	-------------	----------

Code No.	Description	Part No.
----------	-------------	----------

Code No.	Description	Part No.
----------	-------------	----------

Code No.	Description	Part No.
----------	-------------	----------

Code No.	Description	Part No.
----------	-------------	----------

Code No.	Description	Part No.
----------	-------------	----------

Code No.	Description	Part No.
----------	-------------	----------

Code No.	Description	Part No.
----------	-------------	----------

Code No.	Description	Part No.
----------	-------------	----------

Code No.	Description	Part No.
----------	-------------	----------

Code No.	Description	Part No.
----------	-------------	----------

Code No.	Description	Part No.
----------	-------------	----------

Code No.	Description	Part No.
----------	-------------	----------

Code No.	Description	Part No.
----------	-------------	----------

Code No.	Description	Part No.
----------	-------------	----------

Code No.	Description	Part No.
----------	-------------	----------